

# Data Sheet

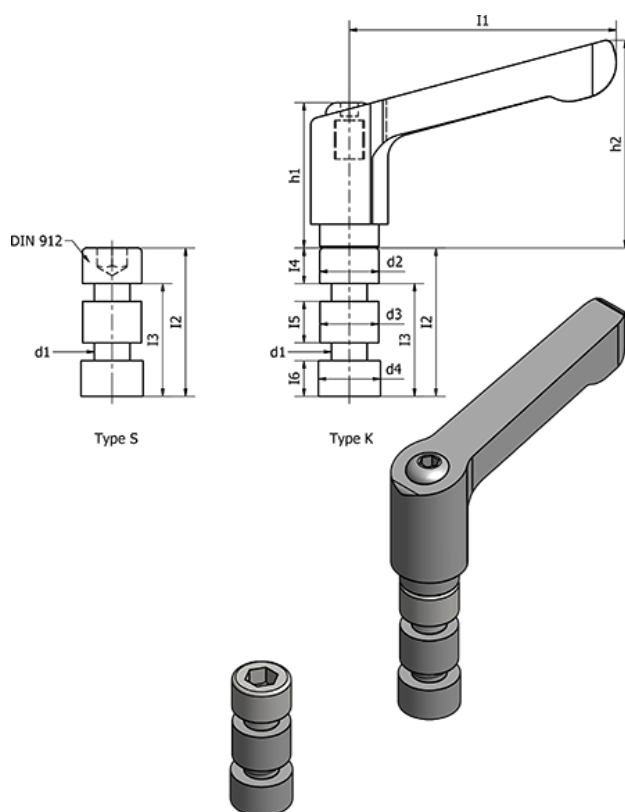

Article number: 205111M625S  
Description: E+G Clamping kit  
GN 511.1-M6-25-S

## Measures



d1 = 6	l3	= 18.5
d2 = 10.5	l4	= 6.5
d3 = 9.9	l5	= 7
d4 = 10.5	l6	= 6
h1 =	Weight (g)	= 150
h2 =		
l1 =		
l2 = 25		